

Operator's Manual



2-Cycle GAS BACKPACK BLOWER

Model No. 316.794990

INCREDI-PULL™
UNBELIEVABLE STARTING EASE™

with **MAXFIRE**  **IGNITION**™



CAUTION: Before using this product, read this manual and follow all safety rules and operating instructions.

- SAFETY
- ASSEMBLY
- OPERATION
- MAINTENANCE
- PARTS LIST

Sears, Roebuck and Co., Hoffman Estates, IL 60179, U.S.A.
Visit our website: www.sears.com/craftsman

TABLE OF CONTENTS

Warranty	Page 2	Maintenance	Pages 13 - 15
Safety Rules	Pages 3 - 8	Troubleshooting	Page 16
Assembly	Page 9	Repair Parts	Page 18
Starting / Stopping instruction	Pages 10 - 11		
Operation	Page 12		

WARRANTY STATEMENT

TWO YEAR LIMITED WARRANTY ON CRAFTSMAN GAS BACKPACK BLOWER

For two years from the date of purchase, when this Blower is used and maintained according to the operator's manual, Sears will repair any defect in material or workmanship free of charge.

This warranty excludes the spark plug and air filter, which are expendable parts that can wear out from normal use in less than two years.

If this Blower is used for commercial or rental purposes, this warranty applies for only 30 days from the date of purchase.

WARRANTY SERVICE IS AVAILABLE BY RETURNING THIS BLOWER TO THE NEAREST SEARS STORE OR SEARS PARTS & REPAIR CENTER IN THE UNITED STATES.

This warranty gives you specific legal rights, and you may also have other rights which vary from state to state.

Sears, Roebuck and Co., Dept. 817WA, Hoffman Estates, IL 60179

CALIFORNIA PROPOSITION 65 WARNING

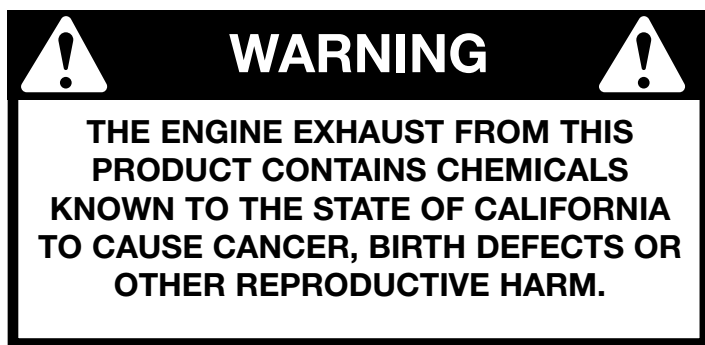

SPARK ARRESTOR NOTE

NOTE: For users on U.S. Forest Land and in the states of California, Maine, Oregon and Washington. All U.S. Forest Land and the state of California (Public Resources Codes 4442 and 4443), Oregon and Washington require, by law that certain internal combustion engines operated on forest brush and/or grass-covered areas be equipped with a spark arrestor, maintained in effective working order, or the engine be constructed, equipped and maintained for the prevention of fire. Check with your state or local authorities for regulations pertaining to these requirements. Failure to follow these requirements could subject you to liability or a fine. **This unit is factory equipped with a spark arrestor.** If it requires replacement, ask a Sears or other qualified service dealer to install the **Spark Arrestor Kit.**

RULES FOR SAFE OPERATION

The purpose of safety symbols is to attract your attention to possible dangers. The safety symbols, and their explanations, deserve your careful attention and understanding. The safety warnings do not by themselves eliminate any danger. The instructions or warnings they give are not substitutes for proper accident prevention measures.

SYMBOL	MEANING
--------	---------



SAFETY ALERT: Indicates danger, warning or caution. Attention is required in order to avoid serious personal injury. May be used in conjunction with other symbols or pictographs.

NOTE: Advises you of information or instructions vital to the operation or maintenance of the equipment.

Read the Operator's Manual(s) and follow all warnings and safety instructions.
Failure to do so can result in serious injury to the operator and/or bystanders.

• IMPORTANT SAFETY INSTRUCTIONS •

READ ALL INSTRUCTIONS BEFORE OPERATING

- Read the instructions carefully. Be familiar with the controls and proper use of the unit.



WARNING: When using the unit, you must follow the safety rules. Please read these instructions before operating the unit in order to ensure the safety of the operator and any bystanders. Please keep these instructions for later use.

- Do not operate this unit when tired, ill, or under the influence of alcohol, drugs, or medication.
- Children must not operate the unit. Teens must be accompanied and guided by an adult.
- All guards and safety attachments must be installed properly before operating the unit.
- Inspect the unit before use. Replace damaged parts. Check for fuel leaks. Make sure all fasteners are in place and secure. Replace parts that are cracked, chipped, or damaged in any way. Do not operate the unit with loose or damaged parts.
- Carefully inspect the area before starting the unit. Remove all debris and hard or sharp objects such as glass, wire, etc.
- Clear the area of children, bystanders, and pets. At a minimum, keep all children, bystanders, and pets outside a 50 feet (15 m.) radius; there still may be a risk to bystanders from thrown objects. Bystanders should be encouraged to wear eye protection. If you are approached, stop the unit immediately.

SYMBOL	MEANING
--------	---------



DANGER: Failure to obey a safety warning will result in serious injury to yourself or to others. Always follow the safety precautions to reduce the risk of fire, electric shock and personal injury.



WARNING: Failure to obey a safety warning can result in injury to yourself and others. Always follow the safety precautions to reduce the risk of fire, electric shock and personal injury.



CAUTION: Failure to obey a safety warning may result in property damage or personal injury to yourself or to others. Always follow the safety precautions to reduce the risk of fire, electric shock and personal injury.

FUEL SAFETY WARNINGS



WARNING: Gasoline is highly flammable, and its vapors can explode if ignited. Take the following precautions:

- Store fuel only in containers specifically designed and approved for the storage of such material.
- Avoid creating a source of ignition for spilled fuel. Do not start the engine until fuel vapors dissipate.
- Always stop the engine and allow it to cool before filling the fuel tank. Never remove the cap of the fuel tank, or add fuel, when the engine is hot. Never operate the unit without the fuel cap securely in place. Loosen the fuel tank cap slowly to relieve any pressure in the tank.
- Add fuel in a clean, well-ventilated outdoor area where there are no sparks or flames. Slowly remove the fuel cap only after stopping engine. Do not smoke while fueling or mixing fuel. Wipe up any spilled fuel from the unit immediately. Always wipe unit dry before using.
- Move the unit at least 30 feet (9.1 m) from the fueling source and site before starting the engine. Do not smoke. Keep sparks and open flames away from the area while adding fuel or operating the unit.

RULES FOR SAFE OPERATION

WHILE OPERATING

- Never start or run the unit inside a closed room or building. Breathing exhaust fumes can kill. Operate this unit only in a well-ventilated outdoor area.
- Wear safety glasses or goggles that are marked as meeting ANSI Z87.1 standards and are marked as such. Wear ear/hearing protection when operating this unit.
- Never run the unit without the the proper equipment attached. When using this unit, always install the blower tubes depending on blower application.
- To reduce the risk of hearing loss associated with sound level(s), always wear ear/hearing protection when operating this unit.
- Wear heavy long pants, boots, gloves, and a long sleeve shirt. Do not wear loose clothing, jewelry, short pants, sandals, or go barefoot. Secure hair above shoulder level.
- To avoid static electricity shock, do not wear rubber gloves or any other insulated gloves while operating this unit.
- Use the unit only in daylight or good artificial light.
- Keep outside surfaces free from oil and fuel.
- Avoid accidental starting. Be in the starting position whenever pulling the starter rope. The operator and unit must be in a stable position while starting. Refer to *Starting/Stopping Instructions*.
- Do not set unit on any surface except a clean, hard area while engine is running. Debris such as gravel, sand, dust, grass, etc. could be picked up by the air intake and thrown out by the discharge opening, damaging unit, property, or causing serious injury to bystanders or operator.
- Use the right tool. Only use this tool for its intended purpose.
- Do not force unit. It will do the job better and with less likelihood of injury at a rate for which it was designed.
- Do not overreach or use from unstable surfaces such as ladders, trees, steep slopes, rooftops, etc. Always keep proper footing and balance.
- Always hold the unit with a firm grip when operating.
- Keep hands, face, and feet away from all moving parts. Do not touch or try to stop the impeller when it is rotating. Do not operate without guards in place.
- Do not put any object into openings. Do not use with any opening blocked; keep free of dirt, debris, and anything that may reduce the air flow.
- Do not touch the engine or muffler. These parts get extremely hot from operation, even after the unit is turned off.
- Do not operate the engine faster than the speed needed to do the job. Do not run the engine at high speed when not in use.
- Always stop the engine when operation is delayed or when walking from one location to another.
- Stop the engine for maintenance, repair, to install or remove the blower tubes attachments. The unit must be stopped and the impeller no longer turning to avoid contact with the rotating blades.
- If you strike or come into contact with a foreign object, stop the engine immediately and check for damage. Do not operate before repairing damage. Do not operate the unit with loose or damaged parts.
- Use only original equipment manufacturer replacement parts when servicing this unit. These parts are available from your authorized service dealer. Do not use unauthorized parts, accessories, or attachments for this unit. Doing so could lead to serious injury to the user, or damage to the unit, and void your warranty.
- Never use this unit for spreading chemicals, fertilizers or other substances which may contain toxic materials.
- To reduce fire hazard, replace faulty muffler and spark arrestor. Keep the engine and muffler free from grass, leaves, excessive grease or carbon build up.
- Turn the engine off and disconnect the spark plug for maintenance of repair.
- Never point the blower or blowing debris in the direction of people, animals or in the direction of windows. Always direct the blowing debris away from people, animals, and windows. Use extra caution when blowing debris near solid objects such as trees, automobiles, walls, etc.

RULES FOR SAFE OPERATION

OTHER SAFETY WARNINGS

- Always disconnect the spark plug before performing maintenance or accessing movable parts.
- Never store the unit, with fuel in the tank, inside a building where fumes may reach an open flame (pilot lights, etc.) or sparks (switches, electrical motors, etc.).
- Allow the engine to cool before storing or transporting. Be sure to secure the unit while transporting.
- Store the unit in a dry place, secured, or at a height to prevent unauthorized use or damage. Keep out of the reach of children.
- Never douse or squirt the unit with water or any other liquid. Keep handles dry, clean, and free from debris. Clean after each use, see *Cleaning and Storage* instructions.
- Keep these instructions. Refer to them often and use them to instruct other users. If you loan this unit to others, also loan these instructions to them.

SPECIAL NOTE: Exposure to vibrations through prolonged use of gasoline powered hand tools could cause blood vessel or nerve damage in the fingers, hands, and joints of people prone to circulation disorders or abnormal swelling. Prolonged use in cold weather has been linked to blood vessel damage in otherwise healthy people. If symptoms occur such as numbness, pain, loss of strength, change in skin color or texture, or loss of feeling in the fingers, hands or joints, discontinue use of this tool and seek medical attention. An anti-vibration system does not guarantee avoidance of these problems. Users who operate power tools on a regular basis must closely monitor their physical condition and the condition of this tool.

SAVE THESE INSTRUCTIONS

RULES FOR SAFE OPERATION

SAFETY AND INTERNATIONAL SYMBOLS

This operator's manual describes safety and international symbols and pictographs that may appear on this product. Read the operator's manual for complete safety, assembly, operating and maintenance and repair information.

SYMBOL	MEANING	SYMBOL	MEANING
	<ul style="list-style-type: none"> • SAFETY ALERT SYMBOL Indicates danger, warning, or caution. May be used in conjunction with other symbols or pictographs. 		<ul style="list-style-type: none"> • ON/OFF CONTROL ON / START / RUN
	<ul style="list-style-type: none"> • READ OPERATOR'S MANUAL WARNING: Read the Operator's Manual(s) and follow all warnings and safety instructions. Failure to do so can result in serious injury to the operator and/or bystanders. 		<ul style="list-style-type: none"> • ON/OFF CONTROL OFF OR STOP
	<ul style="list-style-type: none"> • WEAR EYE, HEARING AND HARD-HAT PROTECTION WARNING: Thrown objects and loud noise can cause severe eye injury and hearing loss. Wear eye protection meeting ANSI Z87.1-1989 standards and ear protection when operating this unit. Wear a hard hat. Use a full face shield when needed. 		
	<ul style="list-style-type: none"> • MINIMUM OPERATING DISTANCE WARNING: Keep children, bystanders, and animals 50 feet (15 meters) away. If approached stop unit immediately. 		<ul style="list-style-type: none"> • RED CHOKE LEVER POSITIONS 1 • FULL Choke Position
	<ul style="list-style-type: none"> • UNLEADED FUEL Always use clean, fresh unleaded fuel. 		<ul style="list-style-type: none"> 2 • PARTIAL Choke Position
	<ul style="list-style-type: none"> • OIL Refer to operator's manual for the proper type of oil. 		<ul style="list-style-type: none"> 3 • RUN Position

RULES FOR SAFE OPERATION

KNOW YOUR BLOWER

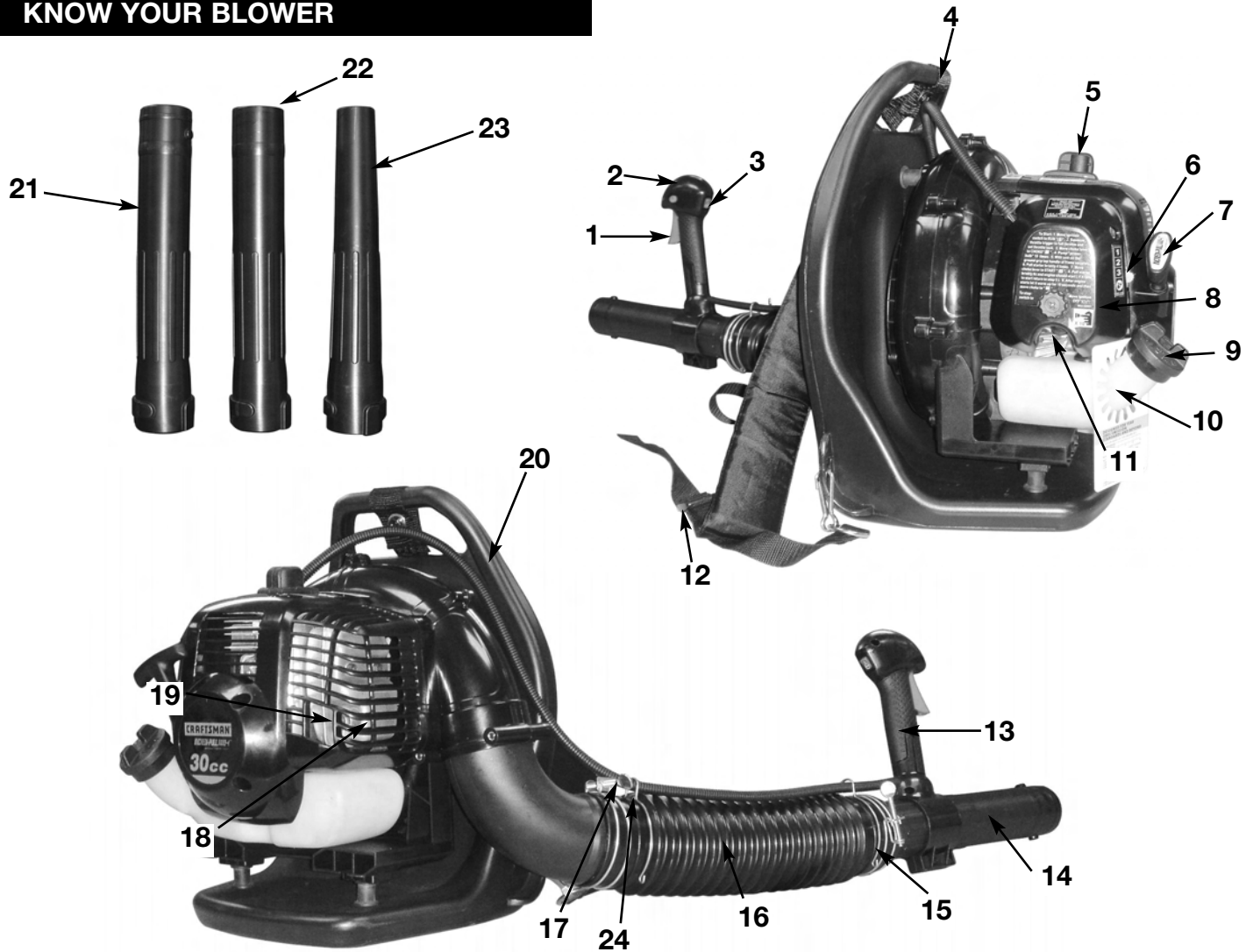

BLOWER COMPONENTS

1. THROTTLE TRIGGER
2. THROTTLE LOCK
3. ON/OFF IGNITION SWITCH
4. TOP ASSIST HANDLE
5. SPARK PLUG WIRE / SPARK PLUG
6. CHOKE LEVER
7. STARTER HANDLE
8. AIR CLEANER COVER
9. FUEL CAP
10. FUEL TANK
11. PRIMER BULB
12. HARNESS
13. CONTROL HANDLE
14. OPERATING TUBE
15. HOSE CLAMP
16. FLEX TUBE
17. THROTTLE LINKAGE
18. MUFFLER COVER
19. SPARK ARRESTER SCREEN
20. VENTED BACK PAD
21. INTERMEDIATE TUBE
22. 56mm NOZZLE
23. 45mm CONCENTRATOR NOZZLE
24. THROTTLE LINKAGE CLIPS

OIL AND FUEL INFORMATION

OIL AND FUEL MIXING INSTRUCTIONS

Old and/or improperly mixed fuel are the main reasons for the unit not running properly. Be sure to use fresh, (less than 60 days old) clean unleaded fuel. Follow the instructions carefully for the proper fuel/oil mixture.

Definition of Blended Fuels

Today's fuels are often a blend of gasoline and oxygenates such as ethanol, methanol, or MTBE (ether). Alcohol-blended fuel absorbs water. As little as 1% water in the fuel can make fuel and oil separate and leads to formation of acids during storage. When using alcohol-blended fuel, use fresh fuel.

Using Blended Fuels

If you choose to use a blended fuel, or its use is unavoidable, follow recommended precautions:

- Always use the fresh fuel mix explained in your operator's manual
- Always agitate the fuel mix before fueling the unit
- Drain the tank and run the engine dry before storing the unit

Using Fuel Additives

The bottle of 2-cycle oil that came with your unit contains a fuel additive which will help inhibit corrosion and minimize the formation of gum deposits. It is recommended that you use our 2-cycle oil with this unit.



If unavailable, use a good 2-cycle oil designed for air-cooled engines along with a fuel additive, such as STA-BIL® Gas Stabilizer or an equivalent. Add 0.8 oz. (23 ml.) of fuel additive per gallon of fuel according to the instructions on the container. NEVER add fuel additives directly to the unit's fuel tank.

	CAUTION: For proper engine operation and maximum reliability, pay strict attention to the oil and fuel mixing instructions on the 2-cycle oil container. Using improperly mixed fuel can severely damage the engine.
---	---

To Obtain Correct Fuel Mix:

Thoroughly mix the proper ratio of 2-cycle engine oil with unleaded gasoline in a separate fuel can. Use a 40:1 fuel/oil ratio. Do not mix them directly in the engine fuel tank. See the table below for specific gas and oil mixing ratios.

NOTE: One gallon (3.8 liters) of unleaded gasoline mixed with one 3.2 oz. (95 ml.) bottle of 2-cycle oil makes a 40:1 fuel/oil ratio.

	+	
UNLEADED GAS		2 CYCLE OIL
1 GALLON US (3.8 LITERS)		3.2 FL. OZ. (95 ml)
1 LITER		25 ml

MIXING RATIO - 40:1

	WARNING: Gasoline is extremely flammable. Ignited Vapors may explode. Always stop the engine and allow it to cool before filling the fuel tank. Do not smoke while filling the tank. Keep sparks and open flames at a distance from the area.
---	--

	WARNING: Remove fuel cap slowly to avoid injury from fuel spray. Never operate the unit without the fuel cap securely in place.
---	--

	WARNING: Add fuel in a clean, well ventilated outdoor area. Wipe up any spilled fuel immediately. Avoid creating a source of ignition for spilled fuel. Do not start the engine until fuel vapors dissipate.
---	---

NOTE: Dispose of the old fuel/oil mix in accordance to Federal, State and Local regulations.

ASSEMBLY INSTRUCTIONS

ATTACH FLEX TUBE

Connect the flexible tube (B) to the fan's outlet tube (A) (Fig. 1) with a hose clamp (C) (Fig. 2) and tighten securely (Fig. 2).

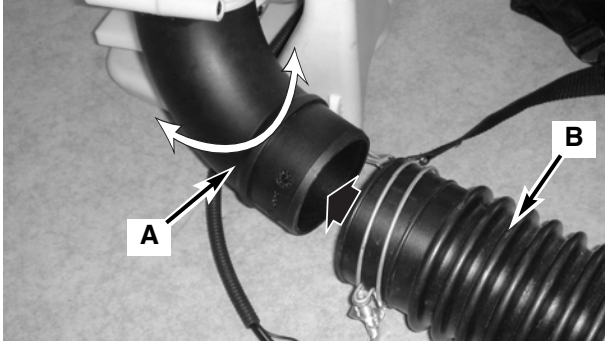

Fig. 1

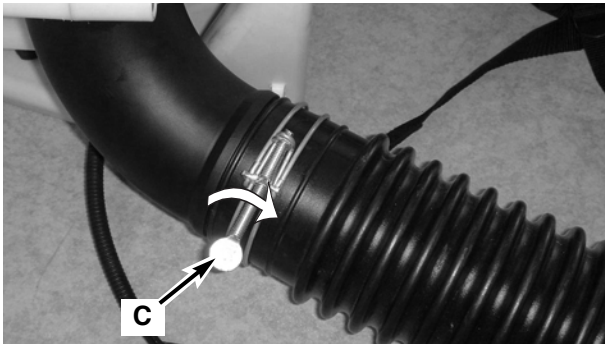

Fig. 2

ATTACH OPERATING TUBE

1. Place the unit on flat surface during assemble. Insure screw mechanism of clamp is positioned away from operator.
2. Turn the rotary ring mark(D) align the throttle handle (F). Then insert the operating tube(E) into the flexible tube (B) (Fig. 3) with a hose clamp (G)(Fig. 4) and tighten securely.
3. Attache throttle linkage clips (# 24-know your blower)- to both ends of the flex tube. (See Fig. 5 and Fig. 6)

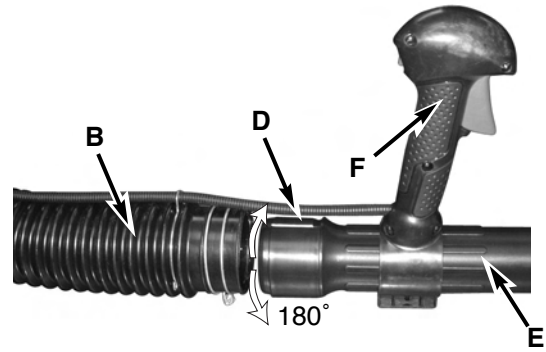

Fig. 3

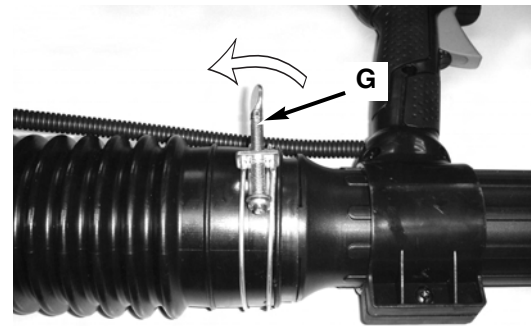

Fig. 4

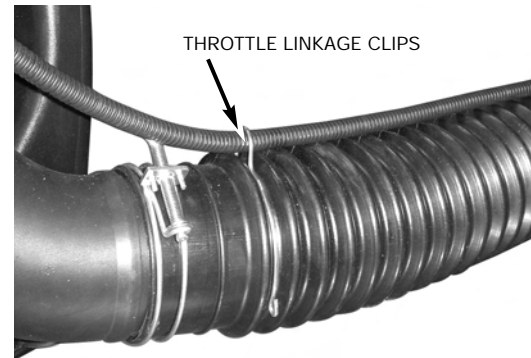

Fig. 5

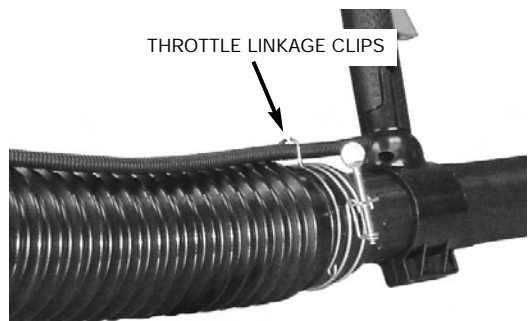

Fig. 6

ASSEMBLY INSTRUCTIONS

ATTACH INTERMEDIATE TUBE AND CONCENTRATOR NOZZLE

Connect the intermediate tube (H) and air nozzle (I). Push the tubes together and turn them clockwise so that they lock together. (Fig. 7)

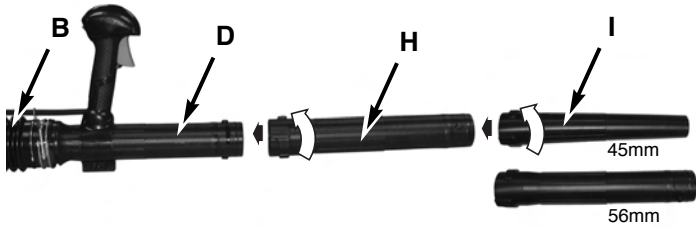

Fig. 7

ADJUST BACK PACK HARNESS AND CONTROL HANDLE

1. Place blower on your back by slipping arms through the shoulder straps as if you were putting on a jacket (Figure 8).
2. Once adjustments have been made, to the straps for user comfort, remove the blower from your back and place on level ground in an upright position.
3. Adjust backpack harness and control handle.



Fig. 8

STARTING/STOPPING INSTRUCTIONS

STARTING A COLD ENGINE (Above 55°F)

Fill fuel tank with proper gas and oil mixture. See FUEL AND LUBRICATION. Set unit upright on ground so that it rests on the back pack frame.

1. Move on/off ignition switch (A) to the "RUN (I)" position. (Figure 9)
2. Pump primer bulb 10 X by pushing up on the bulb (D). (Figure 11)
3. Your unit is designed with a 3 position choke: FULL CHOKE "1", PARTIAL CHOKE "2", and RUN "3". Move choke lever to FULL CHOKE "1" position. (Figure 10) **(DO NOT PRESS THROTTLE LOCK OR TRIGGER.)**
4. With unit on the ground, hold top of blower-not engine housing cover as it may be hot-step on bottom of frame with foot. (Figure 12)

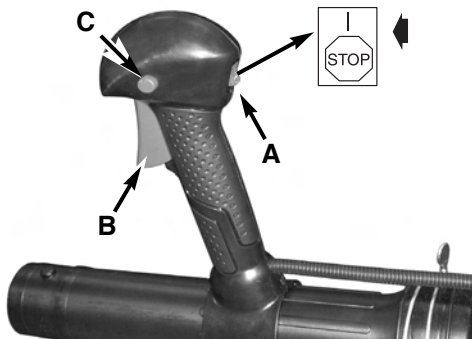

Fig. 9

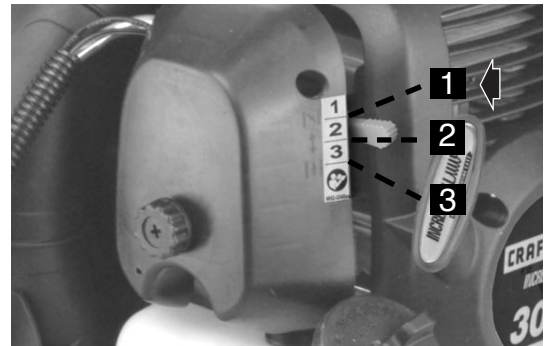

Fig. 10

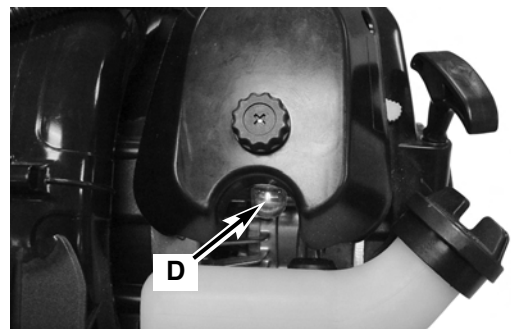

Fig. 11

STARTING/STOPPING INSTRUCTIONS

NOTE: The unit uses the **INCREDI-PULL™** starting system with **MAX FIRE IGNITION™**, which significantly reduces the effort required to start the engine. You must pull the starter rope out far enough to hear the engine attempt to start. There is no need to pull the rope briskly--there is no harsh resistance when pulling. Be aware that this starting method is vastly different from (and much easier than) what you may be used to.

5. Pull starter 4 to 6 times--when unit starts move choke to position 3. If unit fails to start move choke to position 2 and pull 4-6 times until it starts. (Fig.13 & 14)
6. Once engine starts move choke to position 3.
7. After unit starts apply 1/4 throttle slightly and slowly then allow engine to warm up for 30 seconds.
8. Pull throttle to run.

NOTE: If engine fails to start after repeated attempts, refer to Troubleshooting section.

NOTE: Always pull starter rope straight out. Pulling starter at an angle will cause rope to rub against the eyelet. This friction will cause the rope to fray and wear more quickly. Always hold starter handle when rope retracts. Never allow rope to snap back from extended position. This could cause rope to snag or fray and also damage the starter assembly.

COLD STARTS (below 55°F)

1. Switch to "RUN (I)" position.
2. Prime 10 times.
3. Choke in position "1".
4. Do not press throttle lock or trigger.
5. Pull rope until engine starts should be 1-10 times.
6. Move choke to position "3".
7. After unit starts apply 1/4 throttle slightly and slowly then allow engine to warm up for 30 seconds.
8. Press trigger to run.

IMPORTANT IDLING INFORMATION

In some cases due to operating conditions (altitude, temperature etc.) your blower may need a slight adjustment to the idle speed.

After warm up, If unit does not Idle after restarting 2 times, follow these steps to adjust idle.

1. Locate the idle adjustment screw (G) on the carburetor (Figure 15).
2. Using a Phillips or slotted screwdriver - turn screw 1/4 to 1/2 turn clockwise (to the right). Unit should then idle properly.

STOPPING THE ENGINE

Emergency Stopping Procedure. When it is necessary to stop blower engine immediately, DEPRESS the OFF "STOP" switch (A) until the engine stops completely (Figure 16).

Normal Stopping Method. For normal stopping, release trigger and allow engine to return to idle speed. Then DEPRESS the OFF "STOP" switch (A) until the engine stops completely. (Figure 16)

STARTING A WARM ENGINE (Engine has been stopped for no more than 15-20 minutes).

1. Set throttle latch (see step 2 for starting a cold

engine), pull starter rope briskly.

2. If engine does not start, or starts and then stops after 5 rope pulls, follow procedure "STARTING A COLD ENGINE".



Fig. 12

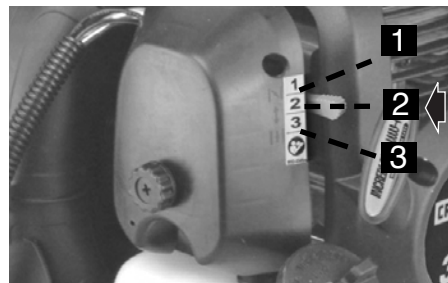

Fig. 13

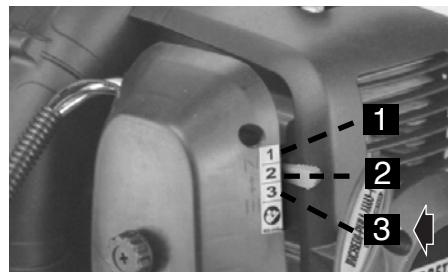

Fig. 14

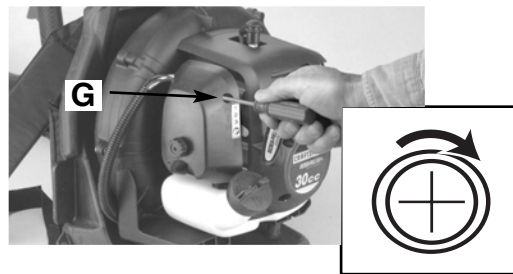

Fig. 15

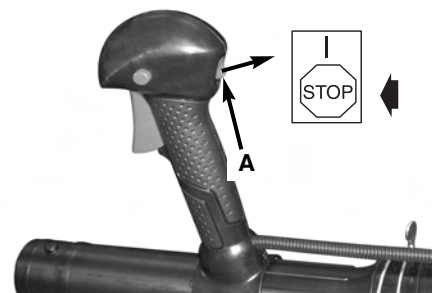



Fig. 16

OPERATING INSTRUCTIONS

BLOWER OPERATIONS

1. Use the blower for trees, shrubs, flower beds, and hard-to-clean areas.
2. Use the unit around buildings and for other normal cleaning procedures.
3. Use the blower around walls, overhangs, fences, and screens.

	WARNING: Because of flying debris, always wear American National Standards Institute approved shielded safety glasses or face shield when operating blower.
--	--

	WARNING: Before using your blower, review Safety Precautions in your User Manual, and all regulations for operation of the unit. These precautions and regulations are for your protection.
--	--

	CAUTION: DO NOT operate the blower with other people or animals in the immediate vicinity. Allow a minimum of 50 feet (15 meters) between operator and other people or animals.
--	--

4. We recommend that a face mask be worn when operating blower in dusty areas.
5. Stand away from the debris, at a distance that will easily allow you to control the direction of blown debris. Never blow debris in direction of bystanders.
6. To control velocity of airstream, blower can be operated at any speed between idle and full throttle. Experience with the unit will help you determine the amount of airflow necessary for each application.
7. Operate power equipment only at reasonable hours--not early in the morning or late at night when people might be disturbed. Comply with times listed in local ordinances.
8. To reduce sound levels, limit the number of pieces of equipment used at any one time.
9. Operate power blowers at the lowest possible throttle speed to do the job.
10. Check your equipment before operation, especially the muffler, air intakes and air filters.
11. Use rakes and brooms to loosen debris before blowing. In dusty conditions, slightly dampen surfaces when water is available.
12. Conserve water by using power blowers instead of hoses for many lawn and garden applications, including areas such as gutters, screens, patios, grills, porches and gardens.
13. Watch out for children, pets, open windows or freshly washed cars, and blow debris safely away.
14. Use intermediate tube plus nozzle of your choice so the airstream can work close to the ground.
15. After using blowers and other equipment, CLEAN UP! Dispose of debris in trash receptacles.

OPERATION INSTRUCTIONS

1. Follow the instructions "STARTING A COLD ENGINE".
2. Once unit is running, place unit on your back by slipping arms through the shoulder straps as if you were putting on a jacket (Figure 17).
3. When preparing to clear an area of debris, always position yourself so that you can control the direction debris will be blown.
4. The control handle (A, Fig. 16) and the flexibility of the blower tube assembly will allow you to clear the most hard-to-reach areas.
5. The hand grip, throttle trigger, throttle lock and ignition on/off switch (B) are all mounted on a swivel handle that offers a wide range of operating positions and comfort (Figure 19).



Fig. 17



Fig. 18



Fig. 19

MAINTENANCE AND REPAIR INSTRUCTIONS

MAINTENANCE SCHEDULE

Perform these required maintenance procedures at the frequency stated in the table. These procedures should also be a part of any seasonal tune-up.

NOTE: Maintenance, replacement, or repair of the emission control devices and system may only be performed by a Sears or other qualified service dealer.

NOTE: Maintenance, replacement, or repair of the emission control devices and system may be performed by a Sears or other qualified service dealer.



WARNING: To prevent serious injury, never perform maintenance or repairs with unit running. Always service and repair a cool unit. Disconnect the spark plug wire to ensure that the unit cannot start.

A good preventive maintenance program of regular inspection and care will increase life and improve performance of your chain saw. This maintenance checklist is a guide for such a program.

Cleaning, adjustment, and part replacement may be required, under certain conditions, at more frequent intervals than those indicated.

CUSTOMER RESPONSIBILITY

MAINTENANCE CHECKLIST		AFTER EACH USE	HOURS OF OPERATION	
ITEM	BEFORE EACH USE		10	20
CHECK FOR LOOSE SCREWS/ NUTS/BOLTS	✓			
CLEAN OR REPLACE THE FILTER		✓		
REPLACE FUEL FILTER			✓	
REPLACE SPARK PLUG			✓	
INSPECT SPARK ARRESTER SCREEN		✓		
INSPECT FUEL HOSES	✓			
INSPECT VACUUM TUBES	✓			

MAINTENANCE AND REPAIR INSTRUCTIONS

AIR FILTER



CAUTION: NEVER operate blower without the air filter. The air filter must be kept clean. If it becomes damaged, install a new filter.

To Clean Air Filter:

1. Loosen knob (A) holding air filter cover in place, remove cover (B) and lift filter (C) from air box (Figure 20 & Figure 21).
2. Wash filter in soap and water. **DO NOT USE GASOLINE!**
3. Air dry filter.
4. Reinstall filter.

NOTE: Replace filter if frayed, torn, damaged or unable to be cleaned.

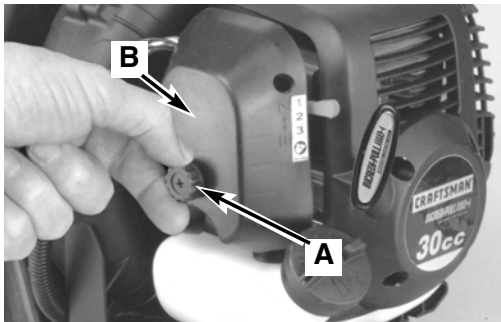

Fig. 20

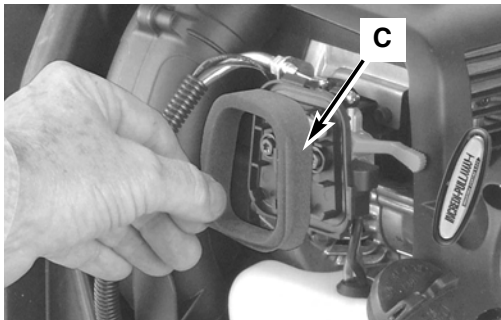

Fig. 21

FUEL CAP / FUEL FILTER



CAUTION: Remove fuel from unit and store in approved container before starting this procedure. Open fuel cap slowly to release any pressure which may have formed in fuel tank.

NOTE: Keep vent (A) on fuel cap clean of debris (Figure 22).

Fuel Filter:

1. Completely remove fuel cap from fuel tank (B) to be able to remove fuel filter (C) from tank. Use a piece of wire (C) with a hook formed at the end to pull filter out of tank. (Figure 23)

2. Pull filter (D) off with a twisting motion. (Figure 24)
3. Replace fuel filter (D). (Figure 24)

NOTE: Never operate the blower without the fuel filter. Internal engine damage could result!

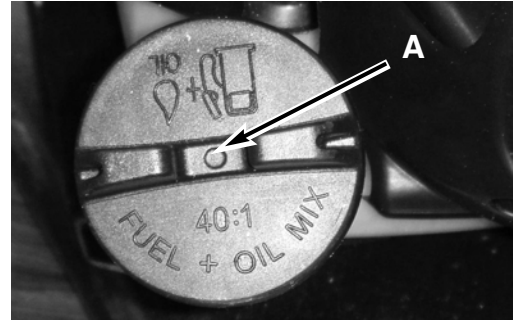

Fig. 22

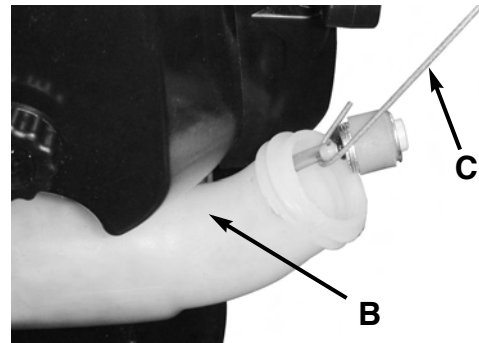

Fig. 23

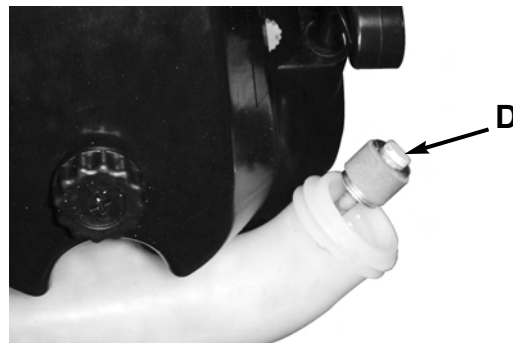

Fig. 24

IDLE ADJUSTMENT

The carburetor was pre-set at the factory for optimum performance. If further adjustments are necessary take your blower to a Sears or other qualified service dealer.

MAINTENANCE AND REPAIR INSTRUCTIONS

SPARK PLUG

1. To remove spark plug (B) (Fig. 26) for cleaning or replacement: make sure engine is off, spark plug is cool, then grasp spark plug boot firmly and remove from spark plug. Remove spark plug with correct spark plug tool. Inspect, clean or replace as needed.
2. Spark plug gap = .025" (.635mm) (Figure 25).
3. Torque to 105 to 130 inch pounds (12 to 15 N•m). Connect spark plug boot.
4. If need replace spark plug with Champion RDJ8J or equivalent.

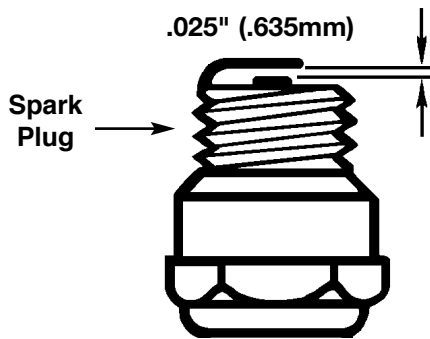

Fig. 25

SPARK ARRESTOR SCREEN/ COLLAR ASSEMBLY

1. To replace spark arrestor screen/collar assembly (A) (Figure 26), use a needle nose pliers and pinch an edge of the collar. Pull out the whole spark arrestor screen assembly.
2. Use the needle nose pliers to push in a new spark arrestor screen assembly by opening the pliers slightly to press the inner surface of the assembly securely into place

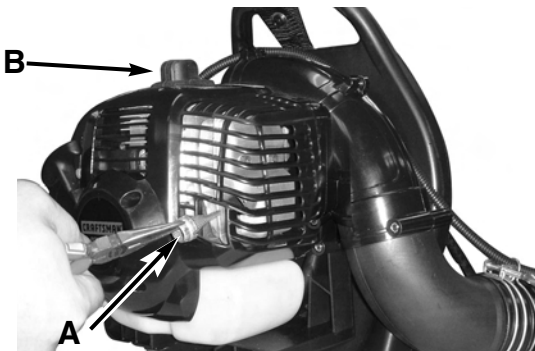

Fig. 26

STORAGE

Failure to follow these steps may cause varnish to form in the carburetor which can cause difficult starting or permanent damage following storage.

1. Perform all the general maintenance recommended in the Maintenance Section of your User Manual.
2. Clean exterior of engine and blower tubes.
3. Drain fuel from the fuel tank by running the unit dry or by removing the fuel cap and tipping the motor housing/fuel tank over and draining oil/fuel mixture into a container with the same 2-cycle fuel mixture.
4. After fuel is drained, start engine.
5. Run engine at idle until unit stops. This will purge the carburetor of fuel.
6. Allow engine to cool (approx. 5 minutes).
7. Using a spark plug wrench, remove the spark plug.
8. Pour 1 teaspoon of clean 2-cycle oil into the combustion chamber. Pull starter rope slowly several times to coat internal components. Replace spark plug.
9. Store unit in a cool, dry place away from any source of ignition such as an oil burner, water heater, etc.

REMOVING A UNIT FROM STORAGE

1. Remove spark plug.
2. Pull starter rope briskly to clear excess oil from combustion chamber.
3. Clean and gap spark plug or install a new spark plug with proper gap. (Fig. 25)
4. Prepare unit for operation.
5. Fill fuel tank with proper fuel / oil mixture. See Fuel and Lubrication Section.

TROUBLESHOOTING

UNIT WON'T START OR STARTS BUT WILL NOT RUN

CAUSE

1. Incorrect starting procedures
2. Incorrect carburetor mixture adjustment setting
3. Fouled spark plug
4. Empty fuel tank
5. Primer bulb was not pressed enough

ACTION

1. Follow instructions in the Starting/Stopping section
2. Have carburetor adjusted by a Sears or other qualified service dealer
3. Clean/gap or replace plug
4. Fill fuel tank with properly mixed fuel
5. Press primer bulb fully and slowly 10 times

UNIT STARTS, BUT ENGINE HAS LOW POWER

CAUSE

1. Fuel filter is plugged
2. Incorrect lever position
3. Dirty spark arrestor screen
4. Dirty air filter
5. Incorrect carburetor mixture adjustment setting service dealer

ACTION

1. Replace the fuel filter
2. Move to Position 3
3. Replace spark arrestor screen
4. Remove, clean and reinstall filter
5. Have carburetor adjusted by a Sears or other qualified

ENGINE HESITATES

CAUSE

1. Incorrect carburetor mixture adjustment setting
2. Air filter is plugged
3. Old or improperly mixed fuel

ACTION

1. Have carburetor adjusted by a Sears or other qualified service dealer
2. Replace or clean the air filter
3. Drain gas tank/add fresh fuel mixture

NO POWER UNDER LOAD

CAUSE

1. Incorrect carburetor mixture adjustment setting
2. Old or improperly mixed fuel
3. Air filter is plugged
4. Fouled spark plug

ACTION

1. Have carburetor adjusted by a Sears or other qualified service dealer
2. Drain gas tank (see Storage)/add fresh fuel mixture
3. Replace or clean the air filter
4. Replace or clean the spark plug

RUNS ERRATICALLY

CAUSE

1. Incorrectly gapped spark plug
2. Plugged spark arrestor
3. Dirty air filter

ACTION

1. Clean/gap or replace plug
2. Clean or replace spark arrestor
3. Clean or replace air filter

SMOKES EXCESSIVELY

CAUSE

1. Incorrect carburetor mixture adjustment setting
2. Incorrect fuel mixture

ACTION

1. Have carburetor adjusted by a Sears or other qualified service dealer
2. Use properly mixed fuel (40:1 mixture)

NOTE: For repairs beyond the minor adjustments listed above, contact your nearest Sears Parts & Repair center at (1-800-4-MY-HOME®) or other qualified service dealer for an adjustment.

SPECIFICATIONS

ENGINE*

Engine Type	Air-Cooled, 2-Cycle
Displacement.....	(30 cc) (1.83 cu in.)
Idle Speed RPM.....	3,400 - 4,400 rpm
Operating RPM.....	7,200+ rpm
Ignition Type	Electronic-MAX FIRE IGNITION™
Ignition Switch	Rocker Switch
Spark Plug Gap.....	0.025 in. (0.635 mm)
Lubrication	Fuel/Oil Mixture
Fuel/Oil Ratio.....	40:1
Carburetor	with primer
Starter	INCREDI-PULL™ Starting system
Muffler	Baffled with Guard
Fuel Tank Capacity.....	20 oz. (600 ml.)

BLOWER

Throttle Control	Finger-Tip Trigger
Blower Velocity	up to 170 mph
Blower Air Output	up to 485 cfm
Approximate Unit Weight (No fuel)	19.5 lb.
Use goggles and hearing protection	

CRAFTSMAN®

SERVICE SPARE PARTS LIST

SPECIFY MODEL NO. WHEN ORDERING PARTS		DATE	REVISED DATE	PAGE
30CC BACK PACK BLOWER		11/19/2004	N/A	1/2
MODEL NO.	79499 / 41AR322G799			

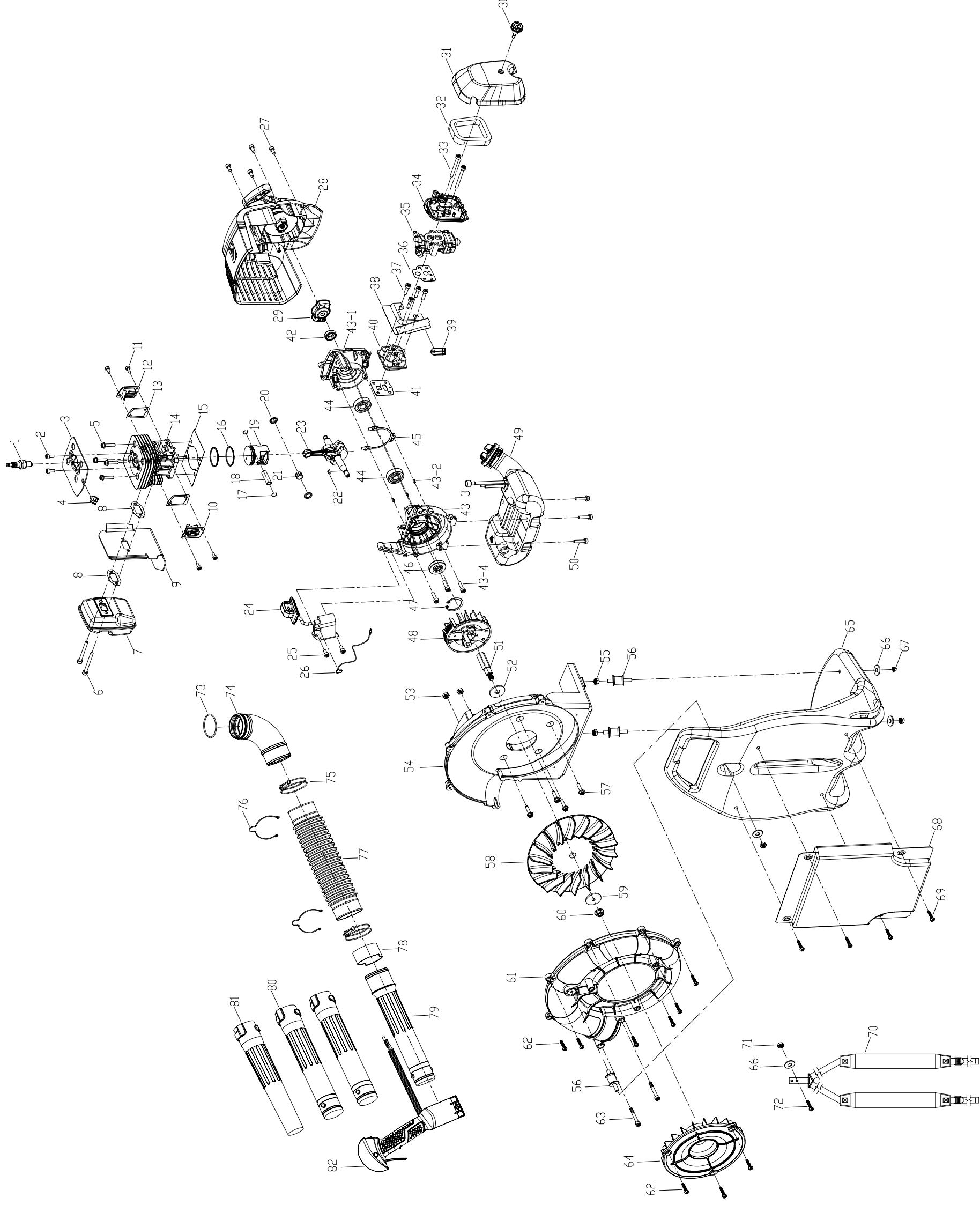

CRAFTSMAN®

SERVICE SPARE PARTS LIST

SPECIFY MODEL NO. WHEN ORDERING PARTS		DATE		REVISED DATE		PAGE	
30CC BACK PACK BLOWER		11/19/2004		N/A		2/2	
MODEL NO. 79499 / 41AR322G799							

No.	STK CODE	JFT Parts No.	Description	Q	No.	STK CODE	JFT Parts No.	Description	Q	No.	STK CODE	JFT Parts No.	Description	Q	No.	STK CODE	JFT Parts No.	Description	Q	
1		MC-9295-310501	SPARK PLUG	1	30		MC-9134-334501	SCREW	1	55		MC-6NDB-06	NUT	1	55		MC-6NDB-06	NUT	1	2
2		MC-9SGEB-05-10	SCREW	2	31		MC-9017-334510	FILTER COVER	1	56		MC-9012-320601	VIBRO-ISOLATING RUBBER	1	56		MC-9012-320601	VIBRO-ISOLATING RUBBER	1	3
3		MC-9211-334502	PLATE, SPARK SIDE	1	32		MC-9183-334501	FILTER	1	57		MC-9SRCBM05-30	SCREW	1	57		MC-9SRCBM05-30	SCREW	1	4
4		MC-9012-330301	GROMMET	1	33		MC-9SGEB-05-52	SCREW	1	58		MC-9151-320601	IMPELLER	2	58		MC-9151-320601	IMPELLER	2	1
5		MC-9SRCB-05-22	SCREW	4	34		MC-9228-334511	FILTER ASSY	1	59		MC-9WFB-8.1-30	WASHER	1	59		MC-9WFB-8.1-30	WASHER	1	1
6		MC-9SXXMBJ05-50	SCREW	2	35		MC-9287-334501	CARBURETOR	1	60		MC-9NHC-08	NUT	1	60		MC-9NHC-08	NUT	1	1
7		MC-9228-334503	MUFFLER ASSY	1	36		MC-9014-334505	CARBURETOR GASKET	1	61		MC-9199-320601	SCREW HOUSING	1	61		MC-9199-320601	SCREW HOUSING	1	1
8		MC-9014-GFP0102	MUFFLER GASKET	2	37		MC-9SKKB-05-19	SCREW	4	62		MC-9SKKB-05-18	SCREW	4	62		MC-9SKKB-05-18	SCREW	4	10
9		MC-9211-334501	MUFFLER PLATE	1	38		MC-9211-334503	PLATE	1	63		MC-9SRCB-05-75	SCREW	1	63		MC-9SRCB-05-75	SCREW	1	2
10		MC-9017-334501	COVER, FLYWHEEL SIDE	1	39		MC-9012-334501	GROMMET	1	64		MC-9017-320601	COVER	1	64		MC-9017-320601	COVER	1	1
11		MC-9SGEB-04-10	SCREW	4	40		MC-9072-334501	INSULATOR	1	65		MC-9038-320602	FRAME	1	65		MC-9038-320602	FRAME	1	1
12		MC-9017-334502	COVER, STARTER SIDE	1	41		MC-9014-334506	INSULATOR GASKET	1	66		MC-6WFB-06-18	WASHER	1	66		MC-6WFB-06-18	WASHER	1	4
13		MC-9014-334507	GASKET	2	42		MC-9157-332101	SEAL	1	67		MC-6NGB-06	NUT	1	67		MC-6NGB-06	NUT	1	3
14		MC-9292-334501F	CYLINDER	1	43		MC-9228-334501	CRANKCASE ASSY	1	68		MC-9014-320601	CUSHION BACK	1	68		MC-9014-320601	CUSHION BACK	1	1
15		MC-9014-334501	GASKET	1	43-1		MC-9151-334502F	CRANKCASE, STARTWE SIDE	1	69		MC-9RGP7.14-16.27	RIVET RIBBED	1	69		MC-9RGP7.14-16.27	RIVET RIBBED	1	1
16		MC-9189-334501	PISTON RING	2	43-2		MC-9PC03-08	PIN	3	70		MC-9149-320601	HARNES	1	70		MC-9149-320601	HARNES	1	1
17		MC-9131-334501	CIRCLIP	2	43-3		MC-9151-334501F	CRANKCASE, FLYWHEEL SIDE	1	71		MC-9NHB-06	NUT	1	71		MC-9NHB-06	NUT	1	1
18		MC-9115-334501	PISTON PIN	1	43-4		MC-9SGEB-05-20	SCREW	3	72		MC-9SKKB-06-15	SCREW	1	72		MC-9SKKB-06-15	SCREW	1	1
19		MC-9290-334501	PISTON	1	44		MC-9DB-620101	BEARING	2	73		MC-9076-320601	O RING	1	73		MC-9076-320601	O RING	1	1
20		MC-9067-334501	AXIS COVER	2	45		MC-9014-334502	GASKET, CRANKCASE SIDE	1	74		MC-9186-320601	ELBOW PIPE	1	74		MC-9186-320601	ELBOW PIPE	1	1
21		MC-9NR-KV9129.8	NEEDLE BEARING	1	46		MC-9157-334501	SEAL	1	75		MC-9036-320601	HOSE BEND	2	75		MC-9036-320601	HOSE BEND	2	2
22		MC-6221-830301	KEY	1	47		MC-9CB-32	C RING	1	76		MC-9036-320602	WIRE CLAMP	2	76		MC-9036-320602	WIRE CLAMP	2	2
23		MC-9228-334502	CRANK/ROD ASSY	1	48		MC-9169-334501	FLYWHEEL	1	77		MC-9186-320602	FLEX PIPE	1	77		MC-9186-320602	FLEX PIPE	1	1
24		MC-9288-320601-CH	IGNITION COIL	1	49		MC-9228-334506	FUEL TANK ASSY	1	78		MC-9189-320601	ACTIVE RING	1	78		MC-9189-320601	ACTIVE RING	1	1
25		MC-9SRCB-05-20	SCREW	2	50		MC-9SKKBY05-18	SCREW	3	79		MC-9186-320605	BASE PIPE	1	79		MC-9186-320605	BASE PIPE	1	1
26		MC-9010-332102	COIL WIRE	1	51		MC-9127-320601	CONNECT AXIS	1	80		MC-9186-320604	MIDDLE PIPE	1	80		MC-9186-320604	MIDDLE PIPE	1	1
27		MC-9SGKB-05-12.5	SCREW	4	52		MC-9WFB-12.1-30	WASHER	1	81		MC-9186-320603	END PIPE	1	81		MC-9186-320603	END PIPE	1	1
28		MC-9228-320602	STARTER HOUSING ASSY	1	53		MC-6NGB-05	NUT	2	82		MC-9228-320603	THROTTLE LEVER ASSY	1	82		MC-9228-320603	THROTTLE LEVER ASSY	1	1
29		MC-9228-MD0107	PAWLS ASSY	1	54		MC-9038-320601	SCREW HOUSING	1					1					1	

Stocking Codes are:

A - Dealer stocked

B - Distributor stocked

C - Factory stocked

California / EPA Emission Control Warranty Statement

Your Warranty Rights and Obligations

The California Air Resources Board, The Environmental Protection Agency and Sears, Roebuck and Co., are pleased to explain the emission control system warranty on your 2005 and later small off-road engine. In California and the 49 states, new small off-road engines must be designed, built and equipped to meet stringent anti-smog standards. Sears must warrant the emission control system on your small off-road engine for the periods of time listed below provided there has been no abuse, neglect or improper maintenance of your small off-road engine.

Your Emission control system may include parts such as the carburetor or fuel-injection system, the ignition system, and catalytic converter. Also included may be hoses, belts, connectors and other emission-related assemblies.

Where a warrantable condition exists, Sears will repair your small off-road engine at no cost to you including diagnosis, parts and labor.

The 2005 and later small off-road engines are warranted for two years. If any emission-related part on your engine is defective, the part will be repaired or replaced by Sears.

Owner's Warranty Responsibilities

- As the small off-road engine owner, you are responsible for the performance of the required maintenance listed in your operator's manual. Sears recommends that you retain all receipts covering maintenance on your small off-road engine, but Sears cannot deny warranty solely for the lack of receipts or for your failure to ensure the performance of all scheduled maintenance.
- As the small off-road engine owner, you should however be aware that Sears may deny you warranty coverage if your small off-road engine or a part has failed due to abuse, neglect, improper maintenance or unapproved modifications.
- You are responsible for presenting your small off-road engine to a Sears authorized service center as soon as problem exists. The warranty repairs should be completed in a reasonable amount of time, not to exceed 30 days.

If you have any questions regarding your warranty rights and responsibilities, you should call 1-800-4-MY-HOME®.

Manufacturer's Warranty Coverage

- The warranty period begins on the date the engine or equipment is delivered to the retail purchaser.
- The manufacturer warrants to the initial owner and each subsequent purchaser, that the engine is free from defects in material and workmanship which cause the failure of a warranted part for a period of two years.
- Repair and replacement of warranted part will be performed at no charge to the owner at an authorized Sears service center. For the nearest location please contact Sears at: 1-800-4-MY-HOME®.
- Any warranted part which is not scheduled for replacement, as required maintenance or which is scheduled only for regular inspection to the effect of "Repair or Replace as Necessary" is warranted for the period. Any warranted part which is scheduled for replacement as required maintenance will be warranted for the period of time up to the first scheduled replacement point for that part.
- The owner will not be charged for diagnostic labor which leads to the determination that a warranted part is defective if the diagnostic work is performed at an authorized Sears Service Center.
- The manufacturer is liable for damages to other engine components caused by the failure of a warranted part still under warranty.
- Failures caused by abuse, neglect or improper maintenance are not covered under warranty.
- The use of add-on or modified parts can be grounds for disallowing a warranty claim. The manufacturer is not liable to cover failures of warranted parts caused by the use of add-on or modified parts.
- In order to file a claim, go to your nearest authorized Sears Service Center. Warranty service or repairs will be provided at all authorized Sears Service Centers.
- Any manufacturer approved replacement part may be used in the performance of any warranty maintenance or repair of emission related parts and will be provided without charge to the owner. Any replacement part that is equivalent in performance or durability may be used in non-warranty maintenance or repair and will not reduce the warranty obligations of the manufacturer.
- The following components are included in the emission related warranty: engine, air filter, carburetor, primer, fuel lines, fuel pick up/fuel filter, ignition module, spark plug and muffler.

Repair Protection Agreements

Congratulations on making a smart purchase.

Your new Craftsman® product is designed and manufactured for years of dependable operation. But like all products, it may require repair from time to time. That's when having a Repair Protection Agreement can save you money and aggravation.

Purchase a Repair Protection Agreement now and protect yourself from unexpected hassle and expense.

Here's what's included in the Agreement:

- ☑ **Expert service** by our 12,000 professional repair specialists
- ☑ **Unlimited service and no charge** for parts and labor on all covered repairs
- ☑ **Product replacement** if your covered product can't be fixed
- ☑ **Discount of 10%** from regular price of service and service-related parts not covered by the agreement; also, 10% off regular price of preventive maintenance check
- ☑ **Fast help by phone** - phone support from a Sears technician on products requiring in-home repair, plus convenient repair scheduling

Once you purchase the Agreement, a simple phone call is all that it takes for you to schedule service. You can call anytime day or night, or schedule a service appointment online.

Sears has over 12,000 professional repair specialists, who have access to over 4.5 million quality parts and accessories. That's the kind of professionalism you can count on to help prolong the life of your new purchase for years to come. Purchase your Repair Protection Agreement today!

**Some limitations and exclusions apply.
For prices and additional information call
1-800-827-6655.**

Sears Installation Service

*For Sears professional installation of home appliances, garage door openers, water heaters, and other major home items, in the U.S.A. call
1-800-4-MY-HOME®*

Get it fixed, at your home or ours!

Your Home

For repair - **in your home** - of **all** major brand appliances, lawn and garden equipment, or heating and cooling systems, **no matter who made it, no matter who sold it!**

For the replacement parts, accessories and owner's manuals that you need to do-it-yourself.

For Sears professional installation of home appliances and items like garage door openers and water heaters.

1-800-4-MY-HOME[®] (1-800-469-4663)

Call anytime, day or night (U.S.A. and Canada)

www.sears.com www.sears.ca

Our Home

For repair of carry-in items like vacuums, lawn equipment, and electronics, call or go on-line for the location of your nearest **Sears Parts & Repair Center.**

1-800-488-1222

Call anytime, day or night (U.S.A. only)

www.sears.com

To purchase a protection agreement (U.S.A.) or maintenance agreement (Canada) on a product serviced by Sears:

1-800-827-6655 (U.S.A.)

1-800-361-6665 (Canada)

Para pedir servicio de reparación a domicilio, y para ordenar piezas:

1-888-SU-HOGARSM

(1-888-784-6427)

Au Canada pour service en français:

1-800-LE-FOYER^{MC}

(1-800-533-6937)

www.sears.ca

